

TOE MAXI™ Style Blade Fuse Rated 58V



Specifications

DIN 72581-3

UL 248 Special Purpose Fuses

cULus Recognized: File No. E211637

Insulating body: Out of thermoplastic (UL 94-V0, heat-resistant)

Cover: Out of thermoplastic (V0, transparent),
Visible melting-element

Connections: Blade contacts
Copper alloy, gal, Sn / alliage cuivreux, gal. Sn
Edge-protected

Breaking capacity: 1,000 A, 58 VDC







Packaging unit: 1,000 pieces

The TOE is a MAXI style fuse rated at 58V, featuring three piece design with copper contacts for excellent reliability in harsh environment conditions and low voltage drop. Current ratings 20A thru 70A. With see-through cover for easy detection of blown fuses.

TOE ist eine Sicherung in MAXI-Bauform mit 58V Nennspannung. Merkmale sind dreiteiliger Aufbau mit Kupferkontakten, niedriger Spannungsabfall und hohe Zuverlässigkeit unter rauen Umgebungsbedingungen. Nennstrom 20A bis 70A, transparente Abdeckung zur leichten Erkennung durchgebrannter Sicherungen.

Time-Current Characteristics / Schmelzeit-Grenzwerte

% of Rating % des Nennstromes	Opening Time Min / Max (s) Schmelzcharakteristik Min / Max (s)
110	100 h / –
135	60 s / 1,800 s
200	2 s / 60 s
350	200 ms / 7 s
600	40 ms / 1 s

Part Number Artikel-Nr.	Current Rating Nennstrom	Housing Color Kennfarbe	Typ. Voltage Drop Typ. Spannungsfall		Cold Resistance Kaltwiderstand	I ² t
			Standard DIN max.	Littelfuse max.		
142.6885.5202	20 A		125 mV	110 mV	3.70 mΩ	1,900 A ² s
142.6885.5302	30 A		100 mV	100 mV	2.20 mΩ	6,000 A ² s
142.6885.5402	40 A		100 mV	80 mV	1.60 mΩ	12,000 A ² s
142.6885.5502	50 A		100 mV	85 mV	1.20 mΩ	26,000 A ² s
142.6885.5602	60 A		100 mV	85 mV	0.90 mΩ	45,000 A ² s
142.6885.5702	70 A		100 mV	80 mV	0.80 mΩ	70,000 A ² s

Corresponding holder see Section "Fuse Holders."

TOE MAXI™ Style Blade Fuse Rated 58V

Dimensions in mm / Maße in mm

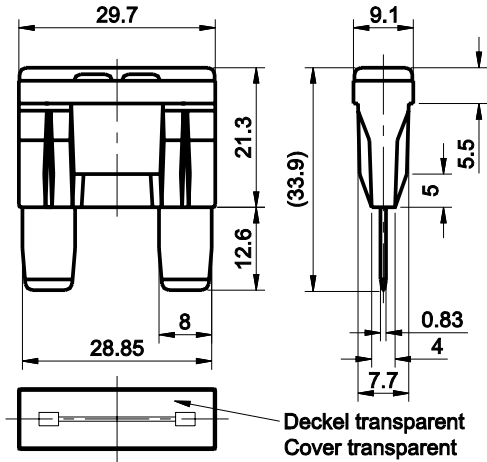

Pre-arcing Time - limits / Schmelzzeit-Grenzwerte DIN

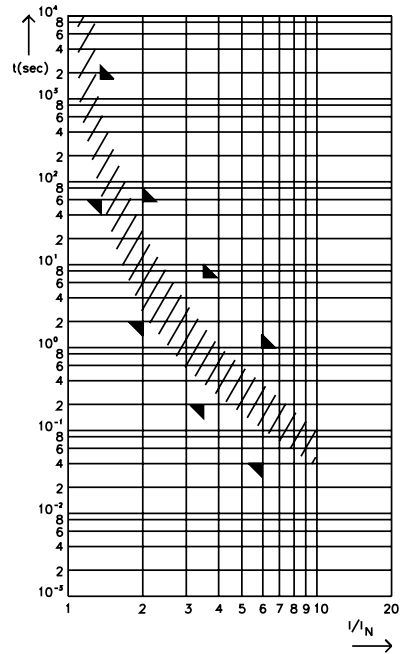

FI = 1.33 (max. operating current: 0.75 x I_{rat} at 23°C)